



OPERATING AND MAINTENANCE MANUAL



CR 9 CCD
Hatz 1 D 90



Weber Maschinentechnik GmbH
Postfach 101465, 57326 Bad Laasphe-Rückershausen
Phone +49 (0) 27 54 / 398-0
Fax +49 (0) 27 54 3 98-101 (switchboard) &
3 98-102 (spare parts)

RAMIRENT

Table of contents

Introduction	4
Safety guidelines	5
Graphic presentation	8
Device description	10
Technical data	11
Activities prior to starting work	12
Starting	14
Compacting	15
Taking out of operation	16
Maintenance overview	17
Maintenance work	18
Operating fluids and fill levels	22
Troubleshooting	23
Storage	24
Contact addresses	27

Introduction

This operating and maintenance manual is designed to facilitate familiarization with your soil compactor, and to enable you to maintain the compactor and use it for its intended purpose. When complying with the instructions in the operating and maintenance manual you help avoid hazards, reduce repair and downtime costs, and increase the reliability and service life of your compactor.

This operating and maintenance manual must always be available at the implementation site of the soil compactor.

If necessary you can obtain additional information from your authorized WEBER dealer, or you can obtain information from one of the contact addresses on the last page.

You can obtain information on the assembled Hatz diesel engine at www.hatz-diesel.com

The valid conformity declaration is enclosed with every machine delivery.

Safety guidelines

General

All safety instructions must be read and complied with, non-compliance results in

- Danger to life and limb of the user
- Impairments to the machine or other property.

In addition to the operating manual, the accident-prevention regulations in the country where the appliance is used must be complied with.

Intended use

The soil compactor should only be used in technically faultless condition, as intended, in a safety-conscious and hazard-conscious manner, in compliance with the instructions in the operating manual. Malfunctions that impair safety must be eliminated without delay.

The CR 9 CCD compactor is designed exclusively for compacting

- Sand
- Gravel
- Crushed rock
- Semi-cohesive mixed material.

Any other use of the soil compactor is considered to be improper use for which the owner shall be exclusively responsible. All liability is rejected if damage occurs due to non-compliance with this provision. This risk is borne solely by the user.

Easily foreseeable misuse

Any use for which the machine is not intended.

Operation

Soil compactors should only be operated by suitable personnel of at least 18 years of age.

Personnel must be instructed in how to guide the compactor by the owner or by the owner's assigned personnel.





The machine operator must comply with traffic regulations. If instructions that affect safety are given by third persons, then the operator must be authorized to reject these instructions.

 Unauthorized persons are forbidden from being in the area of the soil compactor during the compacting process.

Protective equipment

This machine is capable of exceeding the permissible sound level of 80 dB(A). The owner might also face additional dangers when using the machine. Precautionary action must, therefore, be taken.

Protective equipment includes:

-  Hearing protection
-  Hard hat
-  Safety shoes
-  Protective gloves

Operation

Prior to starting work the owner of the compactor must be familiar with the work environment. The work environment includes obstacles in the work and traffic area, the bearing capacity of the ground, as well as the necessary safeguarding of the construction site in the area adjacent to public traffic; and it includes compliance with traffic regulations.

The soil compactor should only be operated when the protective fixtures are mounted. The protective fixtures must all be in functional condition.

At least once per shift the compactor must be checked for apparent defects. If there are apparent defects then operation of the compactor must be stopped immediately and the responsible person must be informed. Prior to restarting, compactor malfunctions that have occurred must be corrected.

Always maintain adequate clearance to the edges of pits and embankments.

Do not drive at ninety degrees to slopes to prevent the compactor from tipping over.

After work has been concluded secure the compactor in accordance with statutory regulations, particularly in the area of public traffic surfaces.

Operation under difficult conditions

 Never inhale the exhaust gas; it contains carbon monoxide, a colorless and odorless gas that is extremely hazardous, which if inhaled even briefly can cause unconsciousness and death.

Never operate the engine in enclosed areas or in areas that are poorly ventilated (tunnels, caves, etc.) Exercise particular caution when operating the engine in the vicinity of people and livestock.

Maintenance and repair work

Only use **original Weber spare parts** to ensure reliable and safe operation for maintenance or repair work.

Hydraulic hose lines must be checked at regular intervals in accordance with standard engineering practice, or they must be replaced at appropriate intervals, even if no signs of safety-relevant defects are present.

Adjusting tasks, service tasks, and inspection tasks must be executed on schedule in accordance with the service display in the COMPATROL® display instrument or as specified in this operating and service manual. These activities should only be executed by instructed personnel.

For repair, maintenance, or inspection work the engine of the compactor must be safeguarded against unintentional starting.

All pressurized lines, particularly hydraulic lines and lines of the injection system of the drive motor must be depressurized before performing maintenance or repair tasks.

For maintenance and repair tasks the compactor must be parked on a level and stable substrate and must be secured from rolling off or tipping over.

Heavy components and subassemblies must be secured on hoisting machines with adequate bearing capacity when they are replaced. Ensure that no hazard exists related to the raised components or subassemblies.

Do not position yourself or work under suspended loads.

 If lubricating oils and fuel come into contact with skin, they can cause skin cancer. Upon contact with the skin, clean affected skin with suitable cleaning agent without delay.

Inspection

Compactors must be inspected in accordance with appropriate implementation conditions and operating conditions, as needed; however an inspection to ensure operationally safe status must be performed by an expert at least once a year. The results of the inspection must be recorded in writing and must be stored at least until the next inspection.

Cleaning work

Prior to cleaning the compactor with a high-pressure cleaner, protect all accessible energized switches, cable connections, etc. against water penetration by masking them off.

Cleaning tasks should only be executed in areas that are suitable and have been approved for this purpose (oil separator amongst others).

Disposal

All operating fluids and auxiliary materials must be disposed of in an environmentally-compatible manner in accordance with country-specific regulations.

Important information for operating and maintenance personnel is marked by pictograms.



Warning against irritants or materials hazardous to health



Warning against a hazardous place



Warning against a suspended load



Wear ear protection



General regulation



Environmental protection



Hard hat



Safety shoes



Protective gloves

Graphic presentation

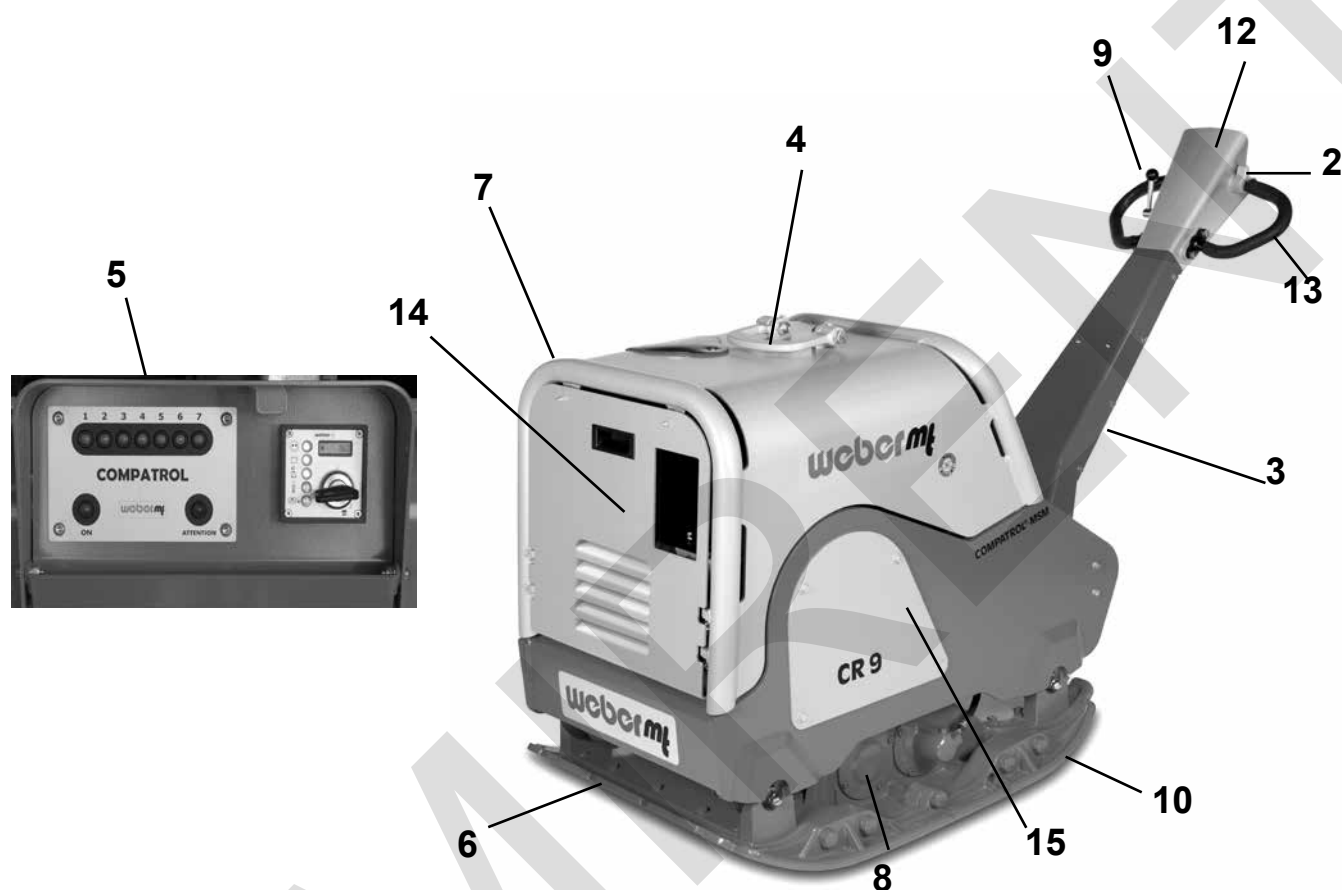

Overall view CR 9 CCD

- 1 Engine (no image)
- 2 Rocker switch
- 3 Manual guidance rod
- 4 Lifting ring
- 5 COMPATROL®
- 6 Base plate
- 7 Protective frame
- 8 Exciter

- 9 Gas lever
- 10 Attachment plates
- 11 Fuse holders (no image)
- 12 Hearing protection (sticker) 
- 13 Handle
- 14 Maintenance cover
- 15 Side panel

Device description

The CR 9 CCD compactor is used for road building and landscaping compaction tasks.

Drive

The compactor is propelled by an air-cooled Hatz diesel engine.

Force is transferred to the exciter mechanically via a V-belt.

Operation

Start the Hatz diesel engine via the electrical start device.

After starting, vibration is switched on via the centrifugal clutch attached to the engine. Use the gas lever to vary the engine speed between idle and full throttle.

Forward and reverse is variably controlled via the rocker switch attached to the manual guidance rod.

Function of the COMPATROL

The ground compaction achieved is measured and visually displayed via LEDs on the COMPATROL® electronic combination instrument placed in the dashboard.

Technical data

	CR 9 CCD
Weight	
Operating weight CECE in kg	740
Dimensions	
Overall length (in mm)	1867
Working width – basic device (in mm)	650
Working width – basic device with attachment plates (in mm)	750 / 900
Height with folded manual guidance rod (in mm)	1167
Base plate length (base in mm)	450
Drive	
Engine manufacturer	Hatz
Type	1 D 90
Performance at operating speed in accordance with ISO 3046-1 (kW)	11
Combustion process	4-stroke diesel
Operating speed (1/min)	2900
Operating speed (ground-dependent in m/min)	28
Incline capacity (ground-dependent in %)	30
Depth of effect (in cm)	80
Area capacity (in m ² /h)	1260
Vibration	
System	Two-wave vibrator
Drive concept	Mechanical
Frequency (in Hz)	65
Centrifugal force (in kN)	100

Noise emissions in accordance with 2000/14/EC	
Sound pressure level L_{PA} ascertained in accordance with EN 500, in dB (A)	99
Sound power level L_{WA} ascertained in accordance with EN ISO 3744 and EN 500, in dB (A)	109
Vibration values	
Root-mean-square acceleration value for hand-arm vibration ascertained in accordance with EN 500 in m/s ²	3.6
 Directive 2006/42/EC has to be complied with by the owner.	

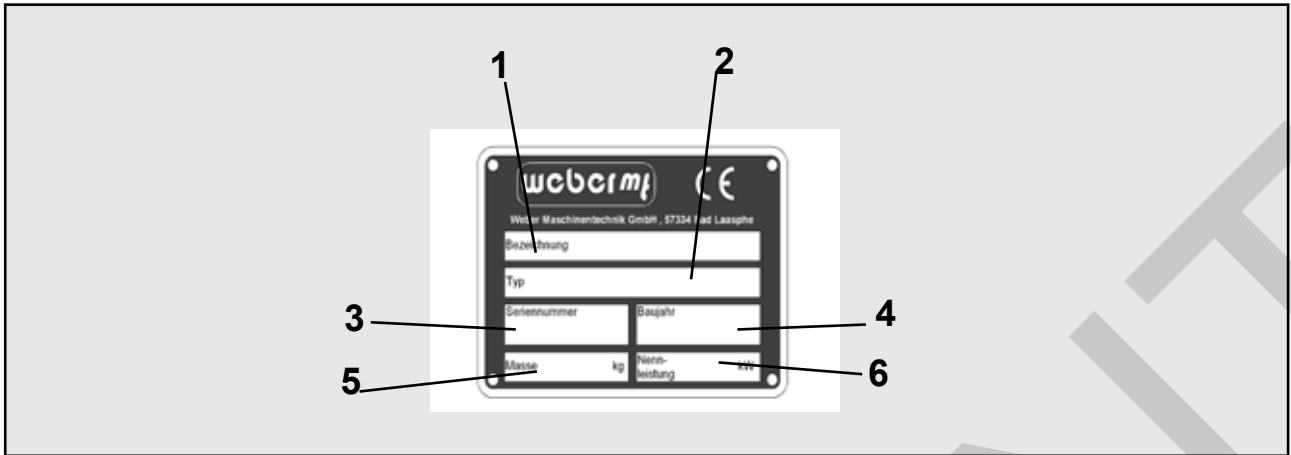

1 Description	2 TYPE
.....
3 Serial number	4 Year of manufacture
.....
5 Weight	6 Rated power kW
.....

Activities prior to starting work

Transport

 When transporting the soil compactor on a vehicle, secure it with suitable restraints.

Fit the crane hook into the lifting ring (1) and lift the machine onto the desired means of transport.

 Only use lifting machines with a minimum bearing capacity of 1000 kg.

 Do not step under suspended loads.

Arrest the manual guidance rod (1) with the spring bolt (2).

Adjusting the manual guidance rod

Adjust the desired work height of the manual guidance rod with the set screw (1).

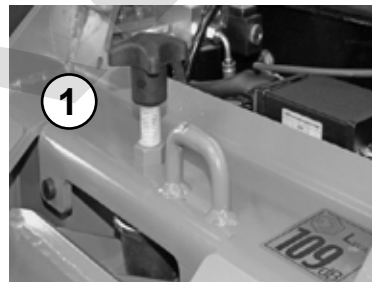
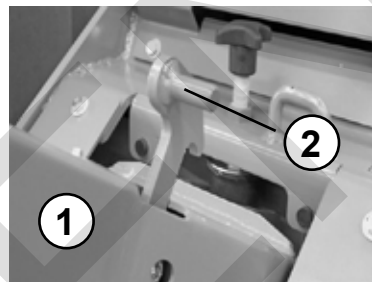
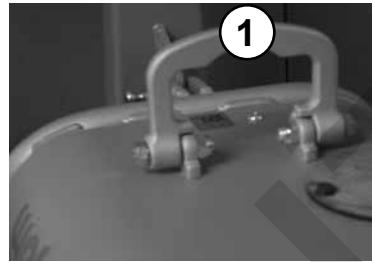

Checking the engine oil level

Fold the maintenance cover (1) forward.



Pull the oil dip stick out of the crankcase.





The correct oil level is between the min. and max. marks.

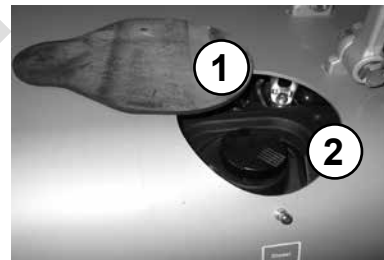

Checking the fuel level

Open the cover (1), unscrew and remove the gas cap (2), check the fill level and, if necessary, top off with clean fuel to the lower edge of the filler neck in accordance with the specification.



 For work at the fuel system, have a suitable fire-extinguishing agent at the ready.

 Fire, naked light, and smoking is forbidden!

Mounting the attachment plates

Tighten the screws of the attachment plates with a torque of 425 NM.



Starting

Open the vandalism flap (1).

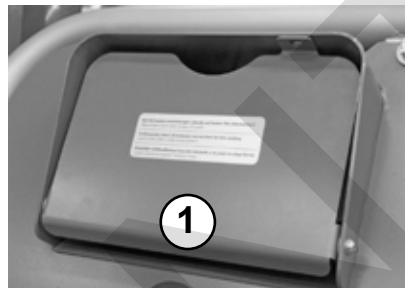

Bring the gas lever into full-throttle position.

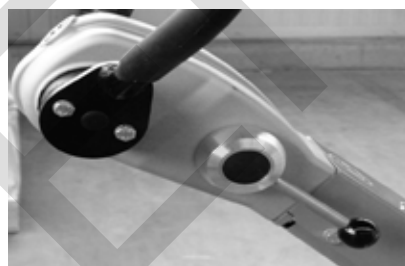

Insert the ignition key (1) and turn to position 1.

Turn the ignition key (1) to position 2.

Release the ignition key as soon as the engine starts.

 Start for a maximum of twenty seconds without interruption. If the engine does not start, repeat starting process after a minute. If the motor does not start after two start processes, seek cause in fault table.

 The ignition key must bounce back to pos. 1 and remain in this position during operation. The charge level indicator (3) and the oil pressure indicator (4) must go out immediately after starting.

The indicator lamp (2) lights up, indicating that the engine is in operation.

The operating hours counter (7) will keep counting the operating hours as long as the ignition is switched on.

 If the ignition key does not bounce back to pos. 1 – turn off the machine immediately – danger of starter damage due to the starter also running during operation.

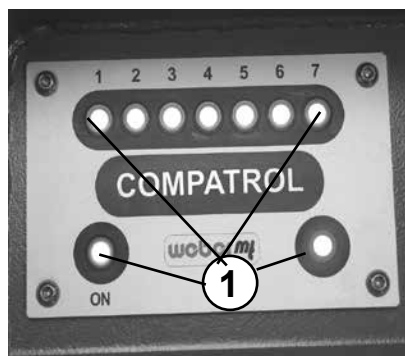
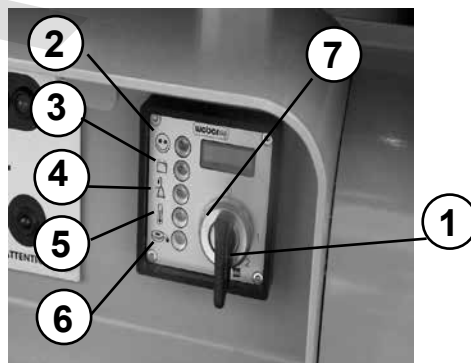

Once the ignition is switched on, the Compatrol® compaction system will perform a function test.

All LEDs (1) light up.

Compacting

Use the rocker switch (1) to control the drive speed.

! Only run machine within reach (2) of the manual guidance rod.

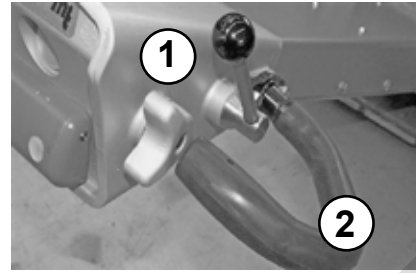

! Pressing the impact plate (1) will automatically switch the machine into forward motion in the direction of travel.

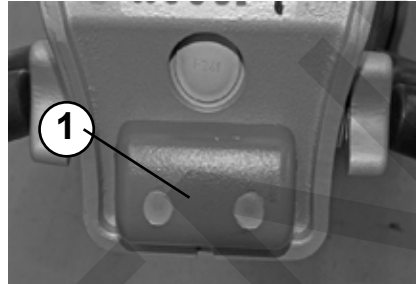

The green LED (1) will be illuminated as soon as operating frequency has been reached, the green LED indicates that the COMPATROL® compaction measurement system is ready for operation.



During the compaction work compaction is continuously measured and displayed visually via the yellow LEDs 1–7 (1). Maximum possible compaction is reached as soon as there is no noticeable increase in the illuminated LEDs.

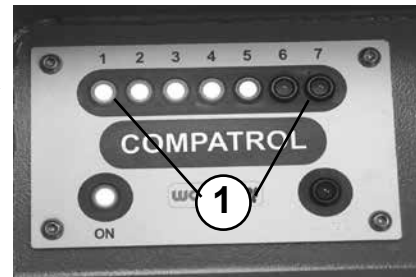

If all LEDs (1 + 2) are illuminated then compaction must be stopped immediately. Maximum compaction is achieved.

! It is possible to loosen the material that will be compacted.

! Under certain circumstances the possibility of machine damage, (due to a substrate that is too hard), cannot be excluded.

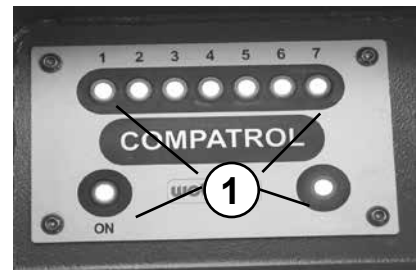

If the red and green LED (1) is illuminated then the material cannot be compacted. The substrate should be replaced with material that can be compacted.

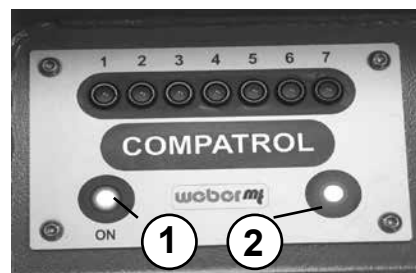

Shutting down

Bring the gas lever (1) into idle position (pull towards the operator).

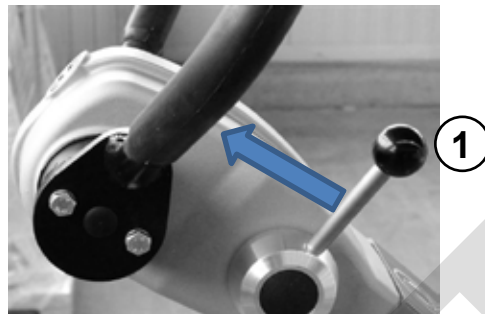

To turn off the engine drag the button (1).



Turn the ignition key (1) from position "1" to position "0".



Pull out the ignition key.

Close the vandalism flap (1) and lock with a padlock.





! During breaks – even if they are short – the machine must be shut down.

! Parked devices that represent an obstacle must be safeguarded against through conspicuous measures.

Maintenance overview

Maintenance interval	Maintenance point	Maintenance activity
After the first 25 operating hours	Engine	<ul style="list-style-type: none"> – Change engine oil – Re-tighten all accessible threaded connections
Every 8 operating hours / daily	Air filter	<ul style="list-style-type: none"> – Clean air filter insert, – check for damage, replace if necessary
Every 150 operating hours / every 6 months	Engine Battery Transmission	<ul style="list-style-type: none"> – Change engine oil – Change the fuel filter – Change oil filter – Check acid level, fill up with distilled water if necessary – Check oil level
Every 150 operating hours / every year	Transmission Exciter	<ul style="list-style-type: none"> – Change oil – Change oil

 The regulations of the engine manufacturer must be complied with in addition to the above maintenance overview!

 Work must be carried out using regulation tools and the operating and maintenance manual must be complied with for all work.

 All maintenance work: Select a collection vessel that is large enough to prevent oil from spilling onto the ground. Dispose of waste oil in an environmentally friendly manner (regulation on waste oils).

 Dispose of oils, greases, cloths soaked in oil, and replaced parts with oil on them in an environmentally friendly manner.

 If lubricating oils and fuel come into contact with skin, they can cause skin cancer. Upon contact with the skin, clean affected skin with suitable cleaning agent without delay.

 If accessible during maintenance, check the condition and stability of all screws.

Maintenance work

Changing the engine oil

Remove side panel (1) and maintenance cover (2).

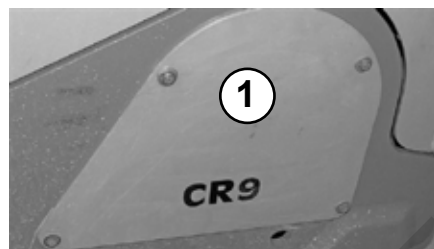

Open the cover cap (1) of the oil filter.

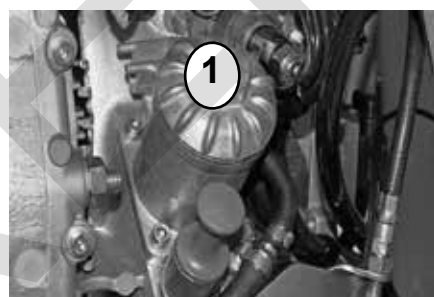

 Only drain engine oil when at operating temperature.

Screw the oil drain pipe (1) onto the engine drain valve (2) and drain off the oil.

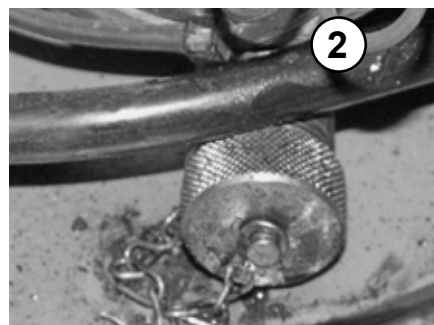

After emptying completely, unscrew the oil drain pipe from the drain valve and screw the cover cap back onto the drain valve. Fill with oil in accordance with the specification.

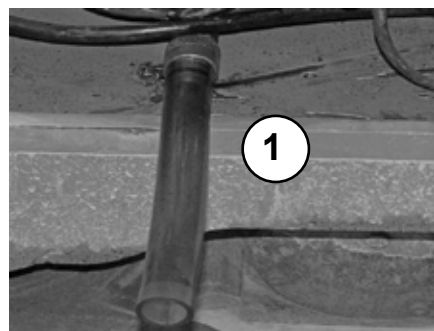

Changing the engine oil filter

Drain engine oil.

Remove the cover cap (1).

 Danger of scalding due to hot oil.

 When working in the area of the engine compartment there is a danger of being burnt!

Replace oil filter (2) with a new element.

After replacing the filter element seal the filter enclosure with the cover cap (1).

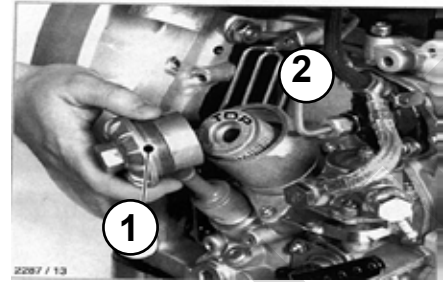

 Pay attention to the "TOP" marking on the oil filter!

Changing the fuel filter

Pull the fuel line (2) off the fuel filter (1) on both sides.

Replace the filter with a new filter element.

 If lubricating oils and fuel come into contact with skin, they can cause skin cancer. Upon contact with the skin, clean affected skin with suitable cleaning agent without delay.

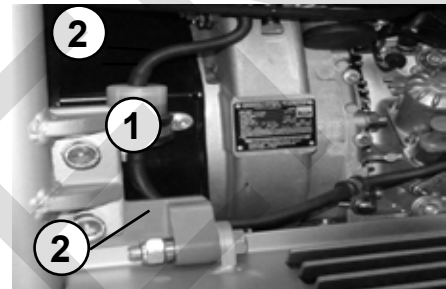

Cleaning/changing the air filter cartridge

Unscrew the air filter cover (1).

Remove the air filter insert (1) from the air filter enclosure.
Clean air filter insert as specified by the engine manufacturer if there is damage or if it is extremely dirty.

 Dispose of oils, greases, cloths soaked in oil, and replaced parts with oil on them in an environmentally friendly manner.

Checking the battery/acid level

 Battery acid is extremely caustic. Protect hands and eyes with suitable protective goggles and gloves.

Remove the cover cap (1).

Check the acid level; if it is too low top off with distilled water until the max. mark is reached.

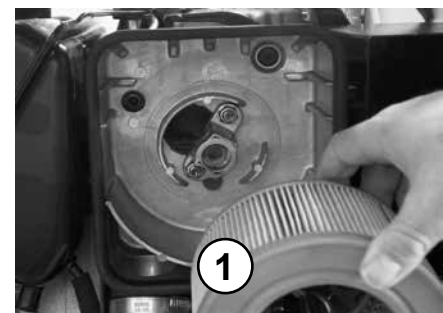
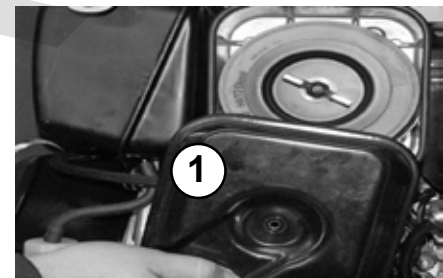

Changing the oil in the exciter

Remove the oil drain screw (1) and drain oil.

To fill – tilt the machine slightly and fill with fresh oil through the drain opening in accordance with the fill level table.



Select a collection vessel that is large enough to prevent oil from spilling on the ground. Dispose of waste oil in an environmentally friendly manner (regulation on waste oils).



Wipe up/off oil slick and oil residue and dispose of fuel-soaked cleaning cloths in an environmentally responsible manner.

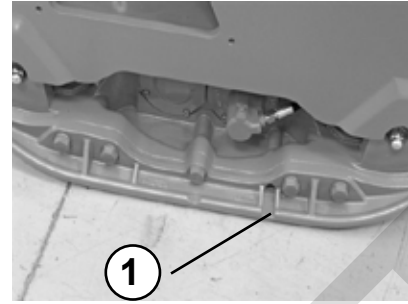

Changing the fuse

Remove the protective caps (1) of the fuse holders. Insert new fuse with a rated value of 20 Amp./3 Amp.



The fuses are housed behind the side panel on the left in the direction of travel.

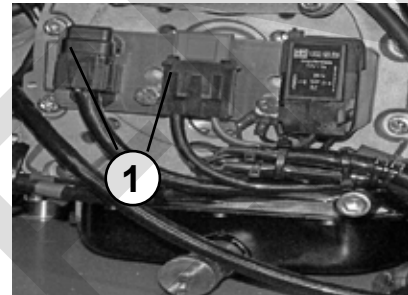

Checking the hydraulic fluid level

Remove the instrument panel (1).

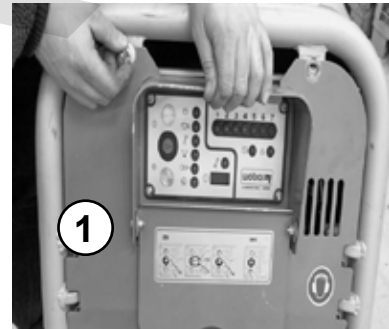

Remove the oil dip stick (1).

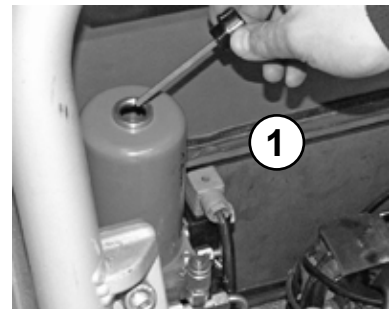

The correct oil level is between the min. and max. marks.

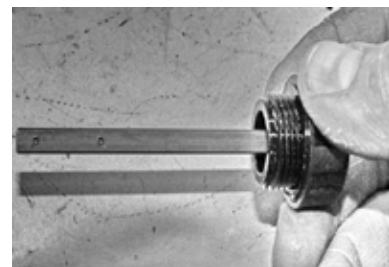

Checking the V-belt

Remove the V-belt guard (1).

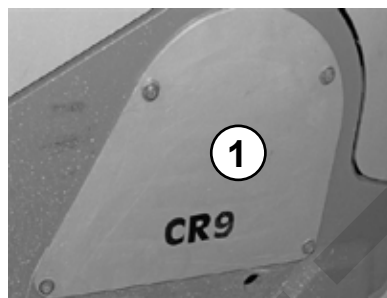

Check the V-belt (1) for cracks, damaged flanks, and wear.

If there is excessive wear – replace the V-belt as specified in the repair manual.



Operating fluids and fill levels

Assembly	Operating material		Quantity
	Summer	Winter	CR 9 CCD
Engine Engine oil	SAE 10 W 40 (-10 ~ +50 °C) API – CD CE-CF-CG or SHPD or CCMC – D4 – D5 – PD2		1.9 l
Fuel tank	Diesel Diesel in accordance with DIN 51601-DK or BS2869-A1/A2 or STM D975-1D/2D		10.0 l
Exciter	Fully-synthetic transmission fluid API GL-5/GL-4 First filling Fuchs Titan SINTOPOID LS SAE 75W-90		1.25 l
Transmission	Transmission fluid DEXRON II-D-ATF First filling Fuchs Titan ATF 3000 or equivalent		As necessary
Battery	Distilled water		As necessary

Troubleshooting

Fault	Possible cause	Remedy
Soil compactor does not start	Operating error Lack of fuel Fuel filter fouled Mech. oil pressure monitor enabled Air filter fouled Battery defective/dis-charged; fuse defective	Execute start process as prescribed Check the fuel level Change the fuel filter See Hatz operating manual, section 4.1.4. Clean/change air filter cartridge Remove/charge battery; replace fuse
No vibration/ no forward motion or insufficient forward motion	Vibrator V-belt defective	Change vibrator V-belt
Unit switches with a delay	Air trapped in the hydraulic transmission system	Bleed the transmission system

Action to be take before long-term storage (longer than a month)

Entire soil compactor	<ul style="list-style-type: none"> - Clean thoroughly - Check watertight - If there are leaks, correct defects
Fuel tank	<ul style="list-style-type: none"> - Empty fuel and fill with clean fuel up to the lower edge of filler neck
Engine	<ul style="list-style-type: none"> - Check oil level, if necessary fill to upper oil-level mark - Check air filter, clean, replace if necessary - Check fuel filter, change if necessary
All bare parts / accelerator / accelerator control cable / fastening bolts	<ul style="list-style-type: none"> - Oil / grease
Starter battery (if there is one)	<ul style="list-style-type: none"> - Remove battery - Check acid level; if it is too low, fill with distilled water up to max. mark of the battery - Store above freezing in a storage room - Attach permanent charger



If the machine is to be stored for longer than six months, then contact the Weber service organization to discuss additional measures.

Charging the starter battery in the machine with the permanent charger

Open protective cover (1) of the charging socket.

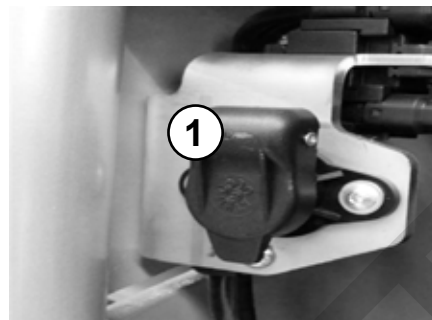

Insert plug into the charging socket.

Connect the battery charger to the mains.



Comply with the device manufacturer's operating manual for use of the battery charger. The operating manual of the charger is enclosed in the packaging of the battery charger. The battery charger BA 200 can be purchased using order no. 021000603.

RAMIRENT



Weber Maschinentechnik GmbH

<p>If you have questions, suggestions, problems, etc. please contact us at one of the following addresses:</p>			
in Germany	<p>WEBER Maschinentechnik GmbH Im Boden 5 – 8, 10 57334 Bad Laasphe – Rückershausen</p>	<p>Phone Fax</p> <p>E-mail</p>	<p>+ 49 (0) 2754-398-0 + 49 (0) 2754-398101- Switchboard + 49 (0) 2754-398102- Replacement parts-direct line g.voelkel@webermt.de</p>
in France	<p>WEBER Technologie SARL 14' rue d' Arsonval 69680 Chassieu</p>	<p>Phone Fax</p> <p>E-mail</p>	<p>+ 33 (0) 472-791020 + 33 (0) 472-791021 france@webermt.com</p>
in Poland	<p>WEBER Maschinentechnik Sp. zo.o. Ul. Grodziska 7 05-830 Stara Wies</p>	<p>Phone Fax</p> <p>E-mail</p>	<p>+ 48 (0) 22 - 739 70-80 + 48 (0) 22 - 739 70-81 + 48 (0) 22 - 739 70-82 info@webermt.com.pl</p>
In the Czech Republic	<p>WEBER MT s.r.o. V Piskovne 2054 278 01 Kralupy nad Vitavou</p>	<p>Phone</p> <p>E-mail</p>	<p>+ 42 (0) 776 222 216 + 42 (0) 776 222 261 info@webermt.cz</p>
in the USA and Canada	<p>WEBER MT, Inc. 45 Dowd Road Bangor, ME 04401</p>	<p>Phone Fax</p> <p>E-mail</p>	<p>+ 1(207) - 947-4990 + 1(207) - 947-5452 sales@webermt.us service@webermt.us</p>
in South America	<p>WEBER Maschinentechnik do Brasil Máquinas Para Construção Ltda. Rua Curt Wacker, nº 45 93332 – 200 Novo Hamburgo, RS Brazil</p>	<p>Phone Fax</p> <p>E-mail</p>	<p>+ 55 (0) 51- 587 3044 + 55 (0) 51- 587 2271 webermt@webermt.com.br</p>

> **Vibration plates**

> **Vibrating tampers**

> **Vibration rollers**

> **Joint cutters**

> **Internal vibrators and converters**

> **Rollers**



Weber MASCHINENTECHNIK GmbH

Im Boden

57334 Bad Laasphe – Rückershausen

Postfach 10 14 65

57326 Bad Laasphe

Phone + 49 (0) 27 54 / 398 0 – Fax +49 (0) 27 54 / 398 101